

DZ 260, DZ 266, DZ 267

Universal Monitors for Speed, Standstill, Direction of Rotation



- | | |
|--------|---|
| DZ260: | Monitor with 3 programmable output relays and analogue output |
| DZ266: | Signal converter with analogue output only (no relays) |
| DZ267: | Monitor with 3 programmable output relays only (no analogue output) |

- Compact and most versatile monitor series for control of overspeed, underspeed, standstill and direction of rotation
- Logical monitoring of remote motion enable signals
- Universal inputs for connection to incremental encoders (TTL, RS422 or HTL), Proximity switches, photocells remote TTL signals
- Extremely wide frequency range, operating from 0.1 Hz up to 1 MHz
- Easy setup by means of four keys and LCD menu
- All models include serial RS232 interface

Operating Instructions



Safety Instructions

- This manual is an essential part of the unit and contains important hints about function, correct handling and commissioning. Non-observance can result in damage to the unit or the machine or even in injury to persons using the equipment!
- The unit must only be installed, connected and activated by a qualified electrician
- It is a must to observe all general and also all country-specific and application-specific safety standards
- When this unit is used with applications where failure or maloperation could cause damage to a machine or hazard to the operating staff, it is indispensable to meet effective precautions in order to avoid such consequences
- Regarding installation, wiring, environmental conditions, screening of cables and earthing, you must follow the general standards of industrial automation industry
- - Errors and omissions excepted –

Version:	Description:
DZ26001b_af/kk/hk_07/07	First edition in English
DZ26002a_af/kk/hk_01/08	Commands "Force Relays" and "Freeze Relays" added
DZ26003a_af/hk_11/08	Command Monitor for remote enable signal

Table of Contents

1.	Introduction.....	4
2.	Available Models.....	4
3.	Electrical Connections	5
3.1.	Power Supply.....	6
3.2.	Auxiliary Output for Encoder Supply	6
3.3.	Impulse Inputs for Encoders and Sensors.....	6
3.4.	Control Inputs	6
3.5.	Serial Interface.....	7
3.6.	Relay Outputs K1 – K3 (DZ260 and DZ 267 only).....	7
3.7.	Scalable Analogue Output (DZ260 and DZ 266 only).....	7
4.	LCD Display and Keys	8
5.	Keypad Operation	9
5.1.	Normal Operation.....	9
5.2.	Keypad Interlock.....	9
5.3.	General Setup Procedure	10
5.4.	Changing Parameters on the Setting Level.....	10
5.5.	Return from the Menu, Time-Out Function	11
5.6.	Reset all Parameters to Factory Default Values	11
6.	Menu Structure and Parameter Description	12
6.1.	Survey of Menus	12
6.2.	Parameter Descriptions.....	13
7.	Example for Commissioning.....	25
8.	Appendix.....	27
8.1.	Hints for Use of the Linearization Function.....	27
8.2.	Data Readout via Serial Interface	28
8.3.	“Relay Action”, override relay states by programmed states.....	29
8.4.	Monitoring of remote motion enable signals.....	30
9.	Specifications and Dimensions.....	31

1. Introduction

This new series of monitors has been designed as control modules for mounting inside of electric control cabinets. The units are suitable for speed monitoring of machines, signaling overspeed, underspeed, zero motion and the direction of rotation. Units providing an analogue output can moreover be used for closed-loop control or feedback purpose within a control system.

Very special advantages of these new monitors are the wide frequency range, the extremely fast response and the remarkable versatility with regard to possible input formats and programmable monitoring functions.

2. Available Models

There are three models available, all with fully similar basic functions, but with different options concerning the outputs.

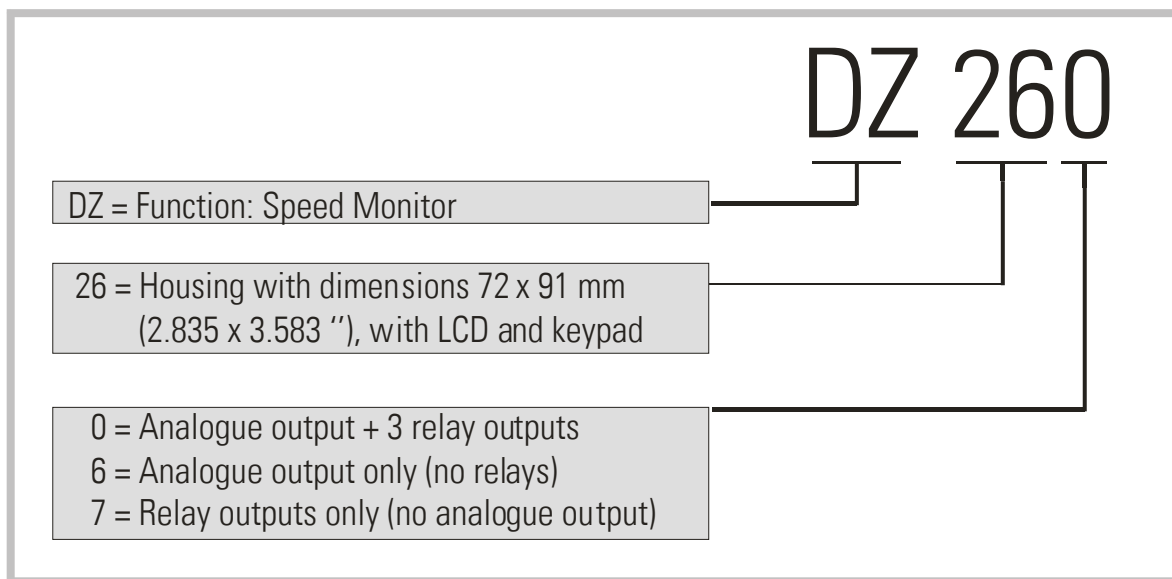

3. Electrical Connections

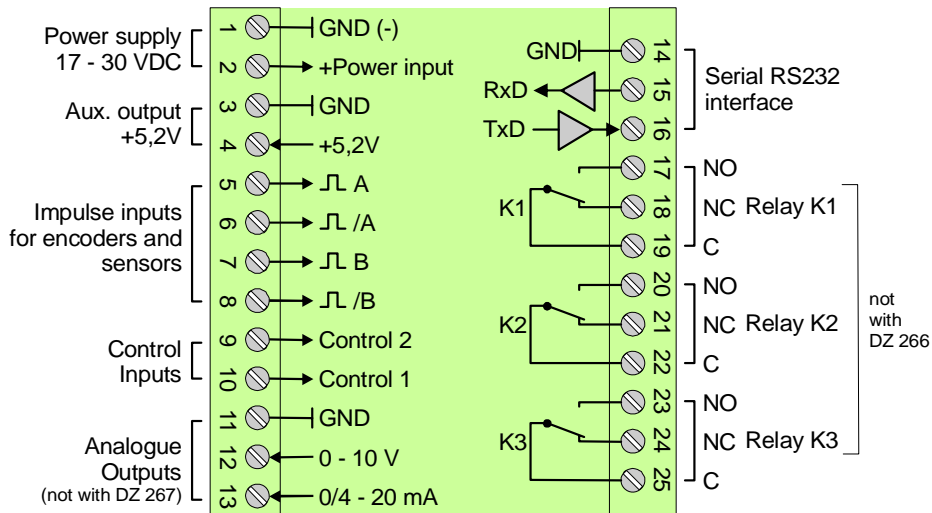

The following table explains the terminal assignment of the different models:

Terminal	Text	Function	Model		
			DZ260	DZ266	DZ267
01	GND	GND, common minus potential	X	X	X
02	Vin	Power input, +17 – 30 VDC	X	X	X
03	GND	GND, common minus potential	X	X	X
04	+5,2V	Aux. output 5,2V / 200 mA	X	X	X
05	A	Impulse input, channel A	X	X	X
06	/A	Impulse input, channel /A (=A inverted)	X	X	X
07	B	Impulse input, channel B	X	X	X
08	/B	Impulse input, channel /B (=B inverted)	X	X	X
09	Control 2	Control input with programmable function	X	X	X
10	Control 1	Control input with programmable function	X	X	X
11	GND	GND, common minus potential	X	X	X
12	+10V Out	Analogue output 0 – 10 V	X	X	
13	20mA out	Analogue output 0 – 20 mA	X	X	
14	GND	GND, common minus potential	X	X	X
15	RxD	Serial RS232 interface, data input	X	X	X
16	TxD	Serial RS232 interface, data output	X	X	X
17	K1NO	Relay 1, normally open contact	X		X
18	K1NC	Relay 1, normally closed contact	X		X
19	K1C	Relay 1, common contact	X		X
20	K2NO	Relay 2, normally open contact	X		X
21	K2NC	Relay 2, normally closed contact	X		X
22	K2C	Relay 2, common contact	X		X
23	K3NO	Relay 3, normally open contact	X		X
24	K3NC	Relay 3, normally closed contact	X		X
25	K3C	Relay 3, common contact	X		X

3.1. Power Supply

The units require a DC supply from 17 to 30 volts which must be applied to terminals 1 and 2. Depending on the input voltage level and internal states, the power consumption may vary and lies in a range of about 70 mA with a 24 volts input (plus encoder currents taken from the auxiliary voltage output).

3.2. Auxiliary Output for Encoder Supply

Terminals 4 and 3 provide a +5.2 VDC / 200 mA auxiliary output for supply of encoders and sensors.

3.3. Impulse Inputs for Encoders and Sensors

The setup menu of the unit allows individual setting of the desired characteristics of the signal inputs. According to the application the units will accept single-channel signals (input A only with no direction information) as well as dual channel signals A/B including information of the direction of rotation. The following input formats and levels are acceptable:

- symmetric differential input with RS422 format A, /A, B, /B
- asymmetric (single-ended) TTL levels (A and/or B only without inverted channels)
- HTL level 10 – 30 volts, alternatively differential (A, /A, B, /B) or single-ended (A and B only, without inverted channels)
- Signals from proximity switches or photocells providing HTL level (10-30 V)
- NAMUR (2-wire) signals

3.4. Control Inputs

Two programmable control inputs allow the assignment of functions like remote start-up-delay, reset of relay lock, hardware interlock of the keypad and similar.

Both inputs provide PNP characteristics and require HTL level. Also it is possible to set the control function to "active LOW" or "active HIGH".

For evaluation of dynamic events the desired "active edge" can be set (rising or falling edge)

3.5. Serial Interface

The serial RS232 interface in general may be used

- for easy setup and commissioning of the units (with use of the OS32 operator software)
- to change settings and parameters by PC or PLC during the operation
- to read out internal states and actual measuring values by PC or PLC

The subsequent drawing shows how to link the monitor with a PC, using the standard 9-pin Sub-D-9 connector

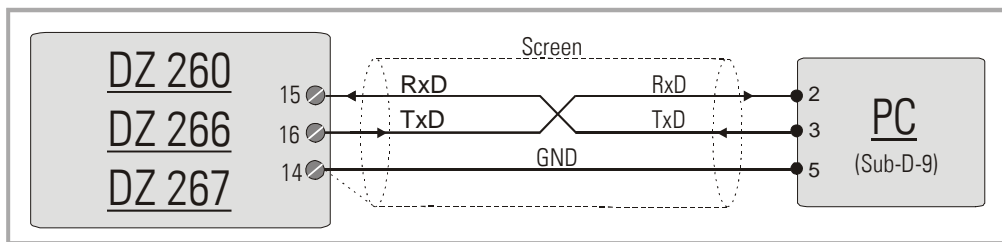

3.6. Relay Outputs K1 – K3 (DZ260 and DZ 267 only)

The units provide three programmable relay outputs (all dry changeover), providing a switching capability of 30 volts / 2 amps DC or 125 volts / 0.6 amps AC or 230 volts / 0.3 amps AC. Both, switching characteristics and monitoring function may be programmed for each of the relays individually.

3.7. Scalable Analogue Output (DZ260 and DZ 266 only)

The units provide a voltage output with a +/-10 volts range (max. load 2 mA) and a current output with ranges 0 – 20 mA respectively 4 – 20 mA (load 0 – 270 Ω). Beginning and end of the desired conversion range can be set by the operator menu. The common potential of both outputs refers to GND.

The total resolution is 14 bits. A settling time of approx. 200 μ s. is required. The overall response time of the analogue outputs primarily depends on the selected Sampling Time setting. After volatile jumps of the input signal, the analogue outputs may need up to two Sampling Time cycles (plus 200 μ sec.) to stabilize.

4. LCD Display and Keys

The units provide a back-lit LCD displays with 2 lines at 16 characters each, and four keys for setup and command control.

During the setup procedure the LCD display indicates the menu with all parameter texts and the set values of the parameters.

During normal operation, the LCD display indicates the following information:

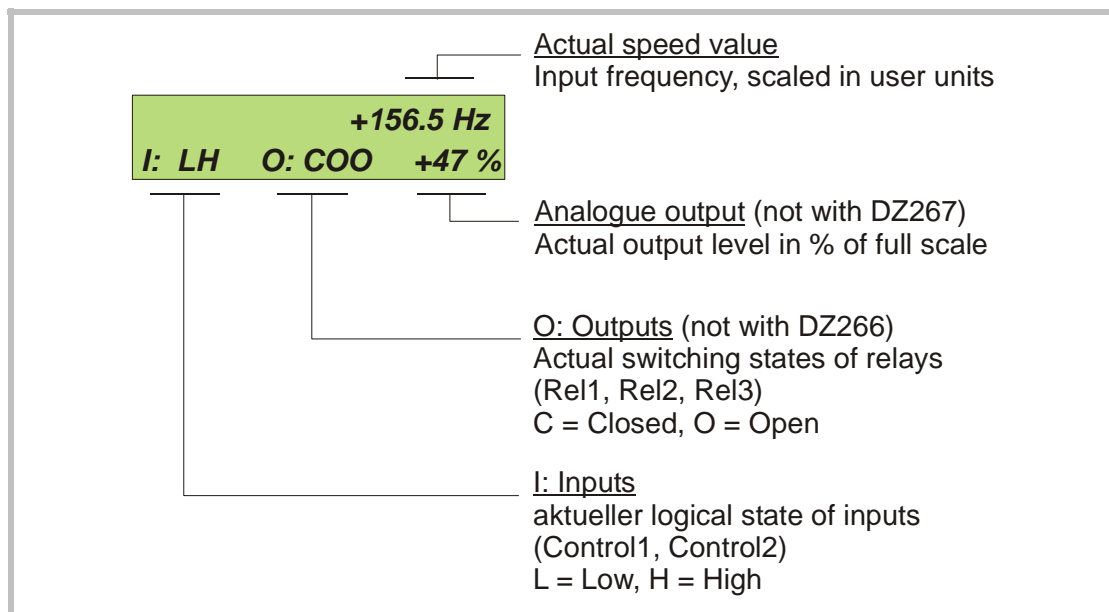



The "Display Menu" allows free scaling of the speed measuring values and the speed-related parameters to any kind of engineering units.

5. Keypad Operation

A summary of all parameters and a detailed description of parameter functions is available under section 6.

For all operation, the units provide four front keys which subsequently will be named as shown below:

			
PROG	UP	DOWN	ENTER

The key functions depend on the actual operating state of the units. Basically we have to distinguish between **Normal Operation** and **Setup Operation**

5.1. Normal Operation

While in normal operation state, the units monitor the speed according to the selected operational parameters and settings. Each of the front keys provides the command functions as attached to it upon setup in the "Command Menu"

5.2. Keypad Interlock

There is a 3-stage conception to protect the keys against unauthorized changes of the configuration respectively against activation of commands.

Stage	Protected Range	Protection by	Key Operations	
			Change of Parameters	Commands
1	---	---	permitted	permitted
2	Menu	Password upon activation of menu	Protection of selectable parts of the menu via password	permitted
3	Keyboard	Hardware-Latch 1	interlocked	permitted
		Hardware Latch 2	All functions interlocked	

The "Key Pad" menu allows to define an individual password for each group of parameters. This function can be used to provide individual access rights to different operators. Upon access to an interlocked section the unit asks for the corresponding password. If the correct password is not entered in time, the unit denies access and automatically returns to normal operation.

The hardware latch function can be activated and deactivated by one of the Control Inputs, or by means of serial access to the corresponding locking register.



Using the Hardware Latch function may accidentally cause a total locking of all functions, when the Control Inputs characteristics have been set inauspiciously.

- In this exceptional case you can release the key functions again by either
- applying the correct logical state (High or Low) to the inputs
 - or resetting the parameters to their default values (see section 5.6.)
 - or change the parameters being responsible for the locking by PC

5.3. General Setup Procedure











To change over from normal operation to the setup state, please keep down the PROG key for at least 2 seconds. After this the menu appears and you can select one of the menu groups. Inside each group you can select the desired parameter and edit the setting according to need. After this you are free to edit more parameters, or to return to normal operation. The function of the different keys during setup is shown in the table below.

Key	Menu Level	Parameter Level	Setting Level
PROG	Save settings and return to normal operation	Return to Menu Level	Check entry, store result, then go back to Parameter Level
UP	Switch over to next menu	Select next parameter	Increment the highlighted digit or scroll the setting upwards
DOWN	Go back to previous menu	Select previous parameter	Decrement the highlighted digit or scroll the setting downwards
ENTER	Switch over to the Parameter Level of the current menu	Switch over to Setting Level	Shifts the highlighted digit one position to the left, or from utmost left to utmost right

5.4. Changing Parameters on the Setting Level

With signed parameters, the front digit can only be changed between „+“ (positive) and „-“ (negative). The subsequent example explains how to change a parameter from originally **1024** to a new value of **250 000**.

The example assumes that you are already on the Setting Level, i.e. you have already selected the corresponding parameter and read its actual value on the display. Highlighted (blinking) digits are marked by background color and indicate the cursor position.

No.	Display	Key action	Comment
00	001024		The actual value 1024 is displayed, with the last digit blinking
01		 4 x	Change last digit to 0
02	001020		Shift cursor to left
03	001020	 2 x	Change highlighted digit to 0
04	001000	 2 x	Shift cursor to left by 2 positions
05	001000		Change highlighted digit to 0
06	000000		Shift cursor to left
07	000000	 5 x	Change highlighted digit to 5
08	050000		Shift cursor to left
09	050000	 2 x	Change highlighted digit to 2
10	250000		Save new setting and return to Parameter Level



5.5. Return from the Menu, Time-Out Function

At any time the PROG key changes the Menu by one level backwards or fully back to the normal operation mode. The menu also switches automatically one level backwards, every time when for 10 seconds no key has been touched (Time-Out-Function).

5.6. Reset all Parameters to Factory Default Values

If applicable, the whole set of parameters can be reset to factory default values (e.g. because a code for the keypad interlocking has been forgotten, or because the unit does no more work correctly for reasons of bad settings). All default values are indicated in the following parameter tables.

To execute this Reset procedure, you have to take the following steps:

- Power the unit down
- Press  and  simultaneously
- Switch power on with both keys held down



Where you decide to execute this action, please be aware that all parameter settings will be lost, and you will have to repeat the whole setup procedure

6. Menu Structure and Parameter Description

All parameters are combined to groups, arranged in several menus. You must only set those parameters which are really relevant for your individual application.

6.1. Survey of Menus

This section provides an overview of the menus and their assignments to the different functions of the units. The menu names are printed bold, and associated parameters are arrayed directly under the menu names.

Menu texts are in English, according to the presentation on the LCD display

Preselect.-Menu* Preselection 1 Preselection 2 Preselection 3	Encoder-Menu Encoder Proper Direction Sampling Time Wait Time Filter Set Value	Ser.Readout Menu Multiplier Divider Offset	Special-Menu Linear Mode** Freq. Control Input Filter
Key-Pad-Menu Protect Menu M01 Protect Menu M02 Protect Menu M03 ... Protect Menu M09 Protect Menu M10 Protect Menu M11	Command-Menu *** Key Up Func. Key Down Func. Key Enter Func. Input 1 Config. Input 1 Func. Input 2 Config. Input 2 Func.	Analogue-Menu** Analogue Format Analogue Start Analogue End Analogue Swing Analogue Offset	Serial-Menu Unit Number Serial Baud Rate Serial Format Serial Protocol Serial Timer Register Code
Switching-Menu* Pulse Time 1 Pulse Time 2 Pulse Time 3 Hysteresis 1 Hysteresis 2 Hysteresis 3 Preselect Mode 1 Preselect Mode 2 Preselect Mode 3 Output Polarity Start up Mode Start up Relay Lock Relay Standstill Time	Linear.-Menu** P1(x) P1(y) P2(x) P2(y) .. P14(x) P14(y) P15(x) P15(y)	Display-Menu Up-Date-Time Display Mode Encoder Factor Multiplier	(*) not relevant with DZ 266 (**) not relevant with DZ 267 (***) partially inactive with DZ 266

6.2. Parameter Descriptions

6.2.1. Preselections



Preselection parameters are only relevant for models DZ260 and DZ267

These parameters assign the desired switching points to the relays. The preselections use the same engineering units as the display of the actual speed (see **Display-Menu**).

Preselection Menu	Code	Setting Range	Default
<u>Preselection1</u> Switching point of relay 1 (engineering units)	„00“	-1 000 000.0 ... +1 000 000.0	100.0
<u>Preselection2</u> Switching point of relay 2 (engineering units)	„01“	-1 000 000.0 ... +1 000 000.0	200.0
<u>Preselection3</u> Switching point of relay 3 (engineering units)	„02“	-1 000 000.0 ... +1 000 000.0	300.0

6.2.2. Definitions for the Encoder or Speed Sensor

Encoder-Menu	Code	Setting Range	Default
<u>Encoder Proper</u> Encoder properties 0 A/B/90° quadrature, RS422 or TTL differential 1 A/B/90° quadrature, single-ended, HTL NPN* 2 A/B/90° quadrature, single-ended, HTL PNP 3 A/B/90° quadrature, single-ended, TTL level 4 A=Impulse, B=direction, RS422 or TTL differential 5 A=Impulse, B=direction, single-ended, HTL NPN* 6 A=Impulse, B=direction, single-ended, HTL PNP 7 A=Impulse, B=direction, single-ended, TTL level 8 Channel A only, RS422 or TTL differential 9 Channel A only, single-ended, HTL NPN* 10 Channel A only, single-ended, HTL PNP 11 Channel A only, single-ended, TTL level	„A0“	0 ... 11	0
<u>Direction</u> Definition of the direction of rotation with quadrature encoders 0 forward when A leads B 1 forward when B leads A	„A1“	0, 1	0



(*) With settings HTL / NPN the input terminals are connected to the power supply voltage of the unit (+24V) via internal pull-up resistors. For this reason it is advisable to first set the encoder properties correctly, prior to connecting TTL encoders to the unit.

Setting HTL / NPN is also suitable for use with NAMUR (2-wire) proximities.
(connect the positive wire of the sensor to the input terminal and the negative wire to GND)

Encoder-Menu	Code	Setting Range	Default
Sampling Time Internal time base for sampling of the input frequency (sec.)	„A2“	0.001..9.999	0.001
Wait Time Time to wait before unit detects zero speed (sec.) Impulse distances greater than this time will be takes as zero	„A3“	1..9.99	1.00
Filter Digital filter for smoothing of unstable frequencies 0 Filter off (very fast response to frequency changes) 1 T (63%) = 1,9 msec. with Sampling Time = 1msec. 2 T (63%) = 3,8 msec. with Sampling Time = 1msec. etc. 7 T (63%) = 122 msec. with Sampling Time = 1msec. (very slow response to frequency changes)	„A4“	0..7	0
Set Value Fixed frequency set value for encoder simulation (Hz) (see also "Command"-Menu)	„A5“	-1 000 000.0 ... +1 000 000.0	0

6.2.3. Serial Readout Menu

An actual value proportional to the input frequency can be read out via serial link, accessing the serial readout register (code :8) As a Basic Value this register uses the scaling set for the analogue output, i.e. a range from 0 to 10 000 units corresponding to 0 - 100,00% of the full scale output (see "Analogue Menu"). This readout can still be rescaled to user-friendly engineering units, using the following parameters:

Serial Readout Menu	Code	Setting Range	Default
Multiplier	„A8“	-99999...99999	10000
Divider	„A9“	0...99999	0
Offset (absolute term)	„B0“	-99999999...99999999	0

$$\text{Readout (:8)} = \text{Basic Value} \times \frac{\text{Multiplier}}{\text{Divider}} + \text{Offset}$$



- The definition of the "Basic Value" occurs in the "Analogue Menu" and is also available for the DZ267 units without analogue output
- the ratio Multiplier / Divider must never be greater than 15 000
- Setting "Divider" to zero will skip the rescaling procedure, resulting in a shorter response time with all functions of the unit

More details about serial communication can be found in the appendix.

6.2.4. Special-Menu

Special-Menu	Code	Setting Range	Default
Linear Mode Programmable linearization for Basic Value and Analogue Output 0 Linearization off 1 Linearization range 0 – +10V 2 Linearization range -10V ... +10V	„B3“	0..2	0
Freq. Control Defines behavior and response of the unit to sudden interruptions of the input frequency. <u>This parameter must only be changed in very special cases and under special instruction of an motrona engineer.</u> <u>Otherwise please use always the default setting "2"!</u>	„B4“	0..2	2
Input Filter Digital filter for limitation of the input frequency 0 Filter off, the full range of frequency will be evaluated 1 Filter to cut frequencies higher than 500 kHz 2 Filter to cut frequencies higher than 100 kHz 3 Filter to cut frequencies higher than 10 kHz	„B5“	0..3	0



Using the Input Filter will cause wrong frequency measurement when you use the unit with frequencies higher than indicated above.

6.2.5. Key-Pad-Menu

Key-Pad-Menu (Passwords for menu groups)	Code	Setting Range	Default
Protect Menu 01 (Preselect.-Menu)	„C0“	0..999999	0
Protect Menu 02 (Encoder-Menu)	„C1“	0 = no interlock 1 – 999 999 = Password for the corresponding group	
Protect Menu 03 (Ser.Readout.-Menu)	„C2“		
Protect Menu 04 (Special-Menu)	„C3“		
Protect Menu 05 (Key-Pad-Menu)	„C4“		
Protect Menu 06 (Command-Menu)	„C5“		
Protect Menu 07 (Analogue-Menu)	„C6“		
Protect Menu 08 (Serial-Menu)	„C7“		
Protect Menu 09 (Switching-Menu)	„C8“		
Protect Menu 10 (Linear-Menu)	„C9“		
Protect Menu 11 (Display-Menu)	„D0“		

6.2.6. Command-Menu

Command-Menu (assignment of functions)	Code	Setting Range	Default
Key Up Func. Supplementary command function of the UP key 0 no function 1 Activation of a serial data transmission 2 Force programmed relay states / Freeze relays (c) (a) 3 Frequency simulation according to parameter "Set Value" 4 Freeze actual input frequency 5 Remote start-up-delay function (a) 6 Release lock of relay 1 (a) 7 Release lock of relay 2 (a) 8 Release lock of relay 3 (a) 9 Release lock of all relays 1-3 (a)	„D7“	0..9	0
Key Down Func. Supplementary command function of the DOWN key (see UP)	„D8“	0..9	0
Key Enter Func. Supplementary command function of the ENTER key (see UP)	„D9“	0..9	0
Input 1 Config. Switching characteristics of input „Control1“ 0 Static low 1 Static High 2 Dynamic, rising edge 3 Dynamic, falling edge	„E0“	0..3	0
Input 1 Func. Control function of input „Control1“ 0 no function 1 Activation of a serial data transmission 2 Force programmed relay states / Freeze relays (c) (a) 3 Frequency simulation according to parameter "Set Value" 4 Freeze actual input frequency 5 Remote start-up-delay function (a) 6 Release lock of relay 1 (a) 7 Release lock of relay 2 (a) 8 Release lock of relay 3 (a) 9 Release lock of all relays 1-3 (a) 10 Interlock for parameter access via keypad (b) 11 Total keypad interlock (b) 12 Command monitor for remote motion enable signal	„E1“	0..12	0
Input 2 Config. (see Input 1 Config.)	„E2“	0..3	0
Input 2 Func. (see Input 1 Func.)	„E3“	0..12	0

(a) these parameters are only relevant for models DZ260 and DZ267

(b) see section 5.2 (c) see section 8.3 (d) see section 8.4

6.2.7. Analogue-Menu

Analogue-Menu (settings for analogue outputs)	Code	Setting Range	Default
Analogue Format Output format of the analogue output 0 Range -10V to +10V 1 Range 0V to +10V 2 Range 4mA to 20mA 3 Range 0mA to 20mA	„E6“	0..3	0
Analogue Start Start value (engineering units) for 0V or -10V or 0mA or 4mA	„E7“	-10000000 ..10000000	0
Analogue End End value (engineering units) for 10V or 20mA	„E8“	-10000000 ..10000000	10000
Analogue Swing Max. output value (100 = 10V or 20mA)	„E9“	0..1000	100
Analogue Offset Shift of the zero position (mV)	„F0“	-9999..9999	0



The settings above are at the same time used to generate the Basic Value 0 - 10 000 (corresponding to 0 - 100,00 %), which finally can be read out from the serial register with access code :8 (see 6.2.3)

6.2.8. Serial Menu

Serial transmissions will operate in either the "PC Mode" or in "Printer Mode".

With "PC-Mode", the unit receives a request string and responds with a corresponding data string. For details of the protocol see separate description "SERPRO".

With "Printer Mode" the unit sends data without any request and under Timer control as described subsequently.

As soon as the unit receives a character, it automatically switches over to PC Mode and operates according to protocol. When for a period of 20 sec. no character has been received, the unit switches automatically back to "Printer Mode" and starts cyclic data transmission again.

Serial -Menu (Configuration of the serial link)	Code	Setting Range	Default
Unit Number (Serial device address) A unit number between 11 and 99 can be assigned to each unit. The address must not contain any zeros (0) since these addresses are reserved for collective addressing of several units.	„90“	11 ... 99	11
Serial Baud Rate (Transmission speed) 0= 9600 Baud 1= 4800 Baud 2= 2400 Baud 3= 1200 Baud 4= 600 Baud 5= 19200 Baud 6= 38400 Baud	„91“	0..6	0
Serial Format (Format of transmit data) 0= 7 Data, Parity even, 1 Stop 1= 7 Data, Parity even, 2 Stop 2= 7 Data, Parity odd, 1 Stop 3= 7 Data, Parity odd, 2 Stop 4= 7 Data, no Parity, 1 Stop 5= 7 Data, no Parity, 2 Stop 6= 8 Data, Parity even, 1 Stop 7= 8 Data, Parity odd, 1 Stop 8= 8 Data, no Parity, 1 Stop 9= 8 Data, no Parity, 2 Stop	„92“	0 ... 9	0

Serial -Menu (Configuration of the serial link)	Code	Setting Range	Default																																			
<p>Serial Protocol</p> <p>Determines the sequence of characters sent, when you use the serial output for cyclic data transmission under timer control (xxxxxxx is the measuring value transmitted).</p> <p>0= Transmission = Unit Nr. – Data, LF, CR 1= Transmission = Data, LF, CR</p> <p>Setting "1" removes the unit address from the string which allows a slightly faster transmission cycle.</p> <table border="1" data-bbox="242 618 916 734"> <thead> <tr> <th colspan="11">Unit No.</th> </tr> </thead> <tbody> <tr> <td>0:</td> <td>1</td> <td>1</td> <td>+/-</td> <td>X</td> <td>X</td> <td>X</td> <td>X</td> <td>X</td> <td>X</td> <td>LF</td> <td>CR</td> </tr> <tr> <td>1:</td> <td></td> <td></td> <td>+/-</td> <td>X</td> <td>X</td> <td>X</td> <td>X</td> <td>X</td> <td>X</td> <td>LF</td> <td>CR</td> </tr> </tbody> </table>	Unit No.											0:	1	1	+/-	X	X	X	X	X	X	LF	CR	1:			+/-	X	X	X	X	X	X	LF	CR	„F3“	0 ... 1	0
Unit No.																																						
0:	1	1	+/-	X	X	X	X	X	X	LF	CR																											
1:			+/-	X	X	X	X	X	X	LF	CR																											
<p>Serial Timer</p> <p>This register determines the cycle time in seconds for cyclic transmission when the Printer Mode is switched on. Range 0.001 to 9.999 seconds. With setting "0" all cyclic transmission is switched off and the unit will only send data upon request (PC mode)</p>	„F4“	0 ... 9.99	0																																			
<p>Register Code</p> <p>Serial access code of the register which, in Printer Mode, should be transmitted with every cycle. The most important registers are shown below.</p> <table border="1" data-bbox="169 1151 989 1464"> <thead> <tr> <th>Setting</th> <th>Code</th> <th>Register contents</th> </tr> </thead> <tbody> <tr> <td>7</td> <td>:7</td> <td>Actual analogue output value 10000 = 10 V = 20 mA</td> </tr> <tr> <td>8</td> <td>:8</td> <td>User-defined readout value (see 6.2.3)</td> </tr> <tr> <td>9</td> <td>:9</td> <td>Frequency detected on the input (Scaling is 0.1 Hz)</td> </tr> <tr> <td>11</td> <td>;1</td> <td>Actual LCD display value</td> </tr> </tbody> </table>	Setting	Code	Register contents	7	:7	Actual analogue output value 10000 = 10 V = 20 mA	8	:8	User-defined readout value (see 6.2.3)	9	:9	Frequency detected on the input (Scaling is 0.1 Hz)	11	;1	Actual LCD display value	„F5“	0 ... 19 (:0) ... (:9)	8																				
Setting	Code	Register contents																																				
7	:7	Actual analogue output value 10000 = 10 V = 20 mA																																				
8	:8	User-defined readout value (see 6.2.3)																																				
9	:9	Frequency detected on the input (Scaling is 0.1 Hz)																																				
11	;1	Actual LCD display value																																				

6.2.9. Switching –Menu



These parameters are only relevant for models DZ260 and DZ267.

Indications | f | mean that only the absolute value of the frequency is considered. With all other indications, frequencies are categorically signed (+ with forward and - with reverse)

Switching -Menu (Switching characteristics of relays)	Code	Setting Range	Default
Pulse Time 1 Rel.1: Duration of timed output, sec. (0=static)	„F8“	0 ... 9.99	0
Pulse Time 2 Rel.2: Duration of timed output, sec. (0=static)	„F9“	0 ... 9.99	0
Pulse Time 3 Rel.3: Duration of timed output, sec. (0=static)	„G0“	0 ... 9.99	0
Hysteresis 1 Rel.1: Switching Hysteresis (engineering units)	„G1“	0 ... 99999.9	0
Hysteresis 2 Rel.2: Switching Hysteresis (engineering units)	„G2“	0 ... 99999.9	0
Hysteresis 3 Rel.3: Switching Hysteresis (engineering units)	„G3“	0 ... 99999.9	0
Preselect Mode 1 (switching operation for Preselection 1 / relay 1) 0 f >= Preselection (catch*) 1 f <= Preselection with start-up-delay (catch*) 2 f == Preselection with start-up-delay (catch*) 3 Standstill (f=0) after expiration of standstill time 4 f >= Preselection (catch*) (also suitable for signalization of forward direction) 5 f <= Preselection (catch*) (also suitable for signalization of reverse direction) 6 f == Preselection (catch*) 7 Relay signals "forward" when a positive frequency (f > 0) is detected. This information disappears upon detection of "standstill" 8 Relay signals "reverse" when a negative frequency (f < 0) is detected. This information disappears upon detection of "standstill"	„G4“	0..8	0
Preselect Mode 2 (switching operation for Preselection 2 / relay 2) see Preselection Mode 1	„G5“	0..8	0
Preselect Mode 3 (switching operation for Preselection 3 / relay 3) see Preselection Mode 1	„G6“	0..8	0
Output Polarity (Relay active „on“ or active „off“ **) Parameter with binary interpretation 0 all Relays are energized when the assigned event occurs 1 Relay 1 inverted 2 Relay 2 inverted 3 Relay 1&2 inverted 4 Relay 3 inverted 5 Relays 1&3 inverted 6 Relays 2&3 inverted 7 All relays inverted	„G7“	0..7	0

*) The corresponding relay can be used with catch operation, when a catch function has been assigned to it under parameter „Lock Relay“

***) Active "on" means the relay will be energized upon occurrence of the assigned event
Active "off" means the relay will be de-energized upon occurrence of the assigned event

Switching -Menu (Switching characteristics of the relays)	Code	Setting Range	Default
Start up Mode Start-up-delay after power-up and after standstill 0 No start-up-delay 1 Start-up-delay 1 second 2 Start-up-delay 2 seconds 3 Start-up-delay 4 seconds 4 Start-up-delay 8 seconds 5 Start-up-delay 16 seconds 6 Start-up-delay 32 seconds 7 Start-up-delay 64 seconds 8 Start-up-delay 128 seconds 9 Automatic delay until to first overstepping of the set value 10 Start-up-delay by remote signal	„G8“	0..10	0
Start up Relay Assignment of a start-up-delay function to the relays 0 No start-up-delay for any of the relays 1 Relay 1 provides start-up-delay 2 Relay 2 provides start-up-delay 3 Relays 1&2 provide start-up-delay 4 Relay 3 provides start-up-delay 5 Relays 1&3 provide start-up-delay 6 Relays 2&3 provide start-up-delay 7 All relays provide start-up-delay	„G9“	0..7	0
Lock Relay Assignment of a catch function to the relays *) 0 No catch function for any of the relays 1 Relay 1 with catch (release by key or by control input) 2 Relay 2 with catch (release by key or by control input) 3 Relays 1&2 with catch (release by key or by control input) 4 Relay 3 with catch (release by key or by control input) 5 Relays 1&3 with catch (release by key or by control input) 6 Relays 2&3 with catch (release by key or by control input) 7 all Relays with catch (release by key or by control input) 8-15 similar to 0 - 7, but catch to release by key or by control input and automatically upon standstill	„H0“	0..15	0
Standstill Time Time setting for standstill definition A time of xx.xx seconds after detection "zero input frequency" the unit signals "standstill" and re-activates the start-up-delays	„H1“	0..99.99	0

*) According to parameter settings, the catch situation can be released by either pressing one of the front keys or by a remote control signal or automatically upon detection of standstill (see "Command menu")

Switching Menu (switching characteristics of the relays)	Code	Range	Default																																				
<p>Relay Action (for more details see section 8.3) Selection of the relays of which the switching state should be overridden by key command or remote command (non-selected relays will continue normally)</p> <ul style="list-style-type: none"> 0 No relay selected 1 Relay 1 2 Relay 2 3 Relays 1 & 2 4 Relay 3 5 Relays 1 & 3 6 Relays 2 & 3 7 All relays selected 8 Freeze actual switching state of all relays 	„K8“	0...8	0																																				
<p>Action Polarity (for more details see section 8.3) Desired override state of the corresponding relays (parameter is out of function when “Relay Action” is set to “8”)</p> <table border="1" data-bbox="236 882 912 1240"> <thead> <tr> <th>Setting</th> <th>Relay K1</th> <th>Relay K2</th> <th>Relay K3</th> </tr> </thead> <tbody> <tr><td>0</td><td>0</td><td>0</td><td>0</td></tr> <tr><td>1</td><td>1</td><td>0</td><td>0</td></tr> <tr><td>2</td><td>0</td><td>1</td><td>0</td></tr> <tr><td>3</td><td>1</td><td>1</td><td>0</td></tr> <tr><td>4</td><td>0</td><td>0</td><td>1</td></tr> <tr><td>5</td><td>1</td><td>0</td><td>1</td></tr> <tr><td>6</td><td>0</td><td>1</td><td>1</td></tr> <tr><td>7</td><td>1</td><td>1</td><td>1</td></tr> </tbody> </table> <p>0 = Coil of the relay is de-energized. 1 = Coil of the relay is energized</p>	Setting	Relay K1	Relay K2	Relay K3	0	0	0	0	1	1	0	0	2	0	1	0	3	1	1	0	4	0	0	1	5	1	0	1	6	0	1	1	7	1	1	1	„K9“	0...7	0
Setting	Relay K1	Relay K2	Relay K3																																				
0	0	0	0																																				
1	1	0	0																																				
2	0	1	0																																				
3	1	1	0																																				
4	0	0	1																																				
5	1	0	1																																				
6	0	1	1																																				
7	1	1	1																																				

6.2.10. Linear.-Menu

Linear.-Menu (Interpolation points for linearization)	Code	Setting Range	Default
P1(x) % Interpolation point 1, original value	„H2“	-100.000...100.000	100.000
P1(y) % Interpolation point 1, substitute value	„H3“		
P2(x) etc.	„H4“		
P2(y) etc.	„H5“		
P3(x)	„H6“		
P3(y)	„H7“		
P4(x)	„H8“		
P4(y)	„H9“		
P5(x)	„I0“		
P5(y)	„I1“		
P6(x)	„I2“		
P6(y)	„I3“		
P7(x)	„I4“		
P7(y)	„I5“		
P8(x)	„I6“		
P8(y)	„I7“		
P9(x)	„I8“		
P9(y)	„I9“		
P10(x)	„J0“		
P10(y)	„J1“		
P11(x)	„J2“		
P11(y)	„J3“		
P12(x)	„J4“		
P12(y)	„J5“		
P13(x)	„J6“		
P13(y)	„J7“		
P14(x)	„J8“		
P14(y)	„J9“		
P15(x)	„K0“		
P15(y)	„K1“		
P16(x)	„K2“		
P16(y)	„K3“		

6.2.11. Display –Menu

Display -Menu	Code	Setting Range	Default
Up-Date-Time Update time of the LCD display (seconds)	„K4“	0.05...1.00	0.10
Display Mode Scaling of the unit's engineering units and the actual LCD display 0 Hz 1 kHz (switch points and analogue output remain in Hz) 2 RPS (revolutions per second) = f / Encoder Factor (*) 3 RPM (revolutions per minute) = 60 x f / Encoder Factor (*) 4 Customer-specific units set by Encoder-Factor und Multiplier Display = f x Multiplier / Encoder Factor (*)	„K5“	0..4	0
Encoder Factor ppr, number of impulses per revolution (with Display-Modes 2 – 4 only)	„K6“	1..99999	1
Multiplier Impulse multiplier (with display-Mode 4 only) Display = f x Multiplier / Encoder Factor	„K7“	1..200	1

*) f = Input frequency in Hz

With display modes 2 – 4 also the switching point settings will use the same engineering units as set for the display

7. Example for Commissioning

The following example is to explain setup and commissioning of the units with a typical application.

- A tooth wheel with 32 teeth should be monitored with respect to speed and standstill
- For speed pick-up we use two proximity switches "Namur-type", which for detection of the direction of rotation are mechanically displaced to generate an impulse offset
- Relay 1 should signal "standstill" when one second after detection of "zero frequency" no further input impulse has been registered
- Relay 2 should generate a timed output pulse of 0.3 seconds when the speed drops below 100 RPM in either forward or reverse direction.
- Relay 3 should switch on and catch when, with forward direction only, the speed exceeds 300 RPM. With reverse direction relays 3 should not respond at all
- Release of the relay 3 catch state should be possible by either a positive signal applied to input "Control1", or by activating the ENTER key

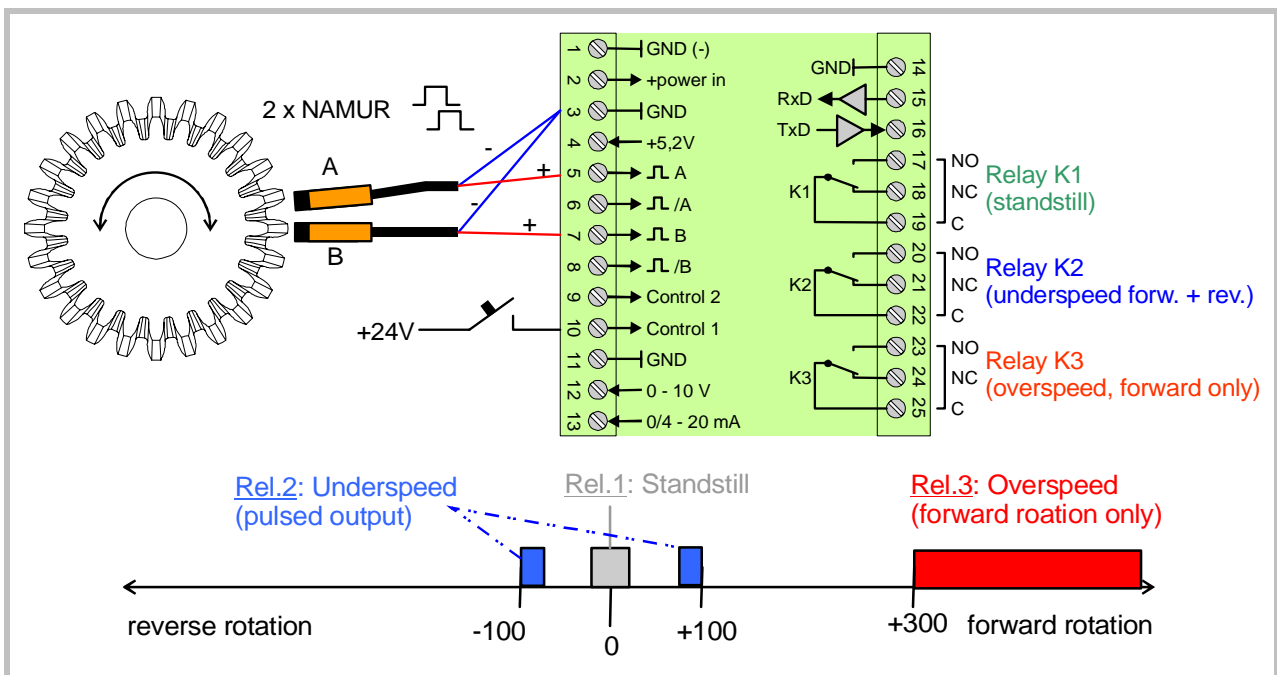

The table below shows the setup procedure for an application according to the previous example. Parameters which are not mentioned are optional, but not relevant for this function.

Nr,	Menu	Parameter	Value	Function
1	Preselect Menu	Preselection1	---	unimportant (relay 1 is used for standstill)
		Preselection2	100	Switching point for "underspeed"
		Preselection3	300	Switching point for "overspeed"
2	Encoder Menu	Encoder Proper. Wait Time	=1 =5,00	A/B/90°, HTL / NPN for two displaced Namur sensors Frequencies < 0,2 Hz are considered as "0"
3	Command Menu	Key Enter Func.	=7	ENTER key to release the relay 3 catch
		Input 1 Config.	=1	Function of "Control1" input is static HIGH
		Input 1 Func.	=7	"Control1" input to release the relay 3 catch
4	Switching Menu	Pulse Time 1	=0	Relay 1 static
		Pulse Time 2	=0.30	Relay 2 timed output 0.3 seconds
		Pulse Time 3	=0	Relay 3 static
		Presel. Mode1	=3	Relay 1 energizes after lapse of standstill time
		Presel. Mode2	=1	Relay 2 energizes when absolute value underpassed
		Presel. Mode3	=4	Relay 3 energizes with positive overstepping only
		Output Polarity	=0	All relays with non-inverted function (energize)
		Start-up Mode	=0	No start-up-delay function
		Start-up Relay	=0	No relay assignment to start-up-delay
		Lock Relay	=4	Relay 3 to operate with catch function
Standstill Time	=1.00	Standstill output 1 second after detection of "frequency = 0" (i.e. 6 seconds after the last input pulse)		
5	Display Menu	Display Mode	=3	Engineering units are RPM
		Encoder Factor	=32	Tooth wheel generates 32 pulses per revolution
		Multiplier	=1	No specific impulse scaling

8. Appendix

8.1. Hints for Use of the Linearization Function

The linearization function of these units allow to convert a linear input frequency into a non-linear developing, which can be indicated on the LCD display and which is also available as analogue signal or as serial data, for further processing.

There are 16 programmable x/y coordinates available, which can be set in any desired distance over the full conversion range. Between two coordinates, the unit uses linear interpolation. Therefore it is advisable to use more coordinates in a range with strong curves and only a few coordinates where the curvature is less.

To specify your desired linearisation curve, you must first set the „Linearisation Mode“ register to either 1 or 2.

Use registers P1(x) to P16(x) to specify the coordinates on the x-axis. These are the measuring values that the unit normally would generate according to the actual input frequency. These settings must be in % of full scale.

Now enter the attached values to registers P1(y) to P16(y). These are the values that the unit will generate instead of the x- values, i.e. P2(y) will substitute P2(x) etc.



- x-registers must use continuously increasing settings, i.e. P1(x) must have the lowest and P16(x) must have the highest setting
- All entries use a percental format of xx.xxx% full scale. Setting 000.000% means zero output and setting 100.000% means full scale output.
- With Linearisation Mode set to 1, it is a must to set P1(x) to 0% and P16(x) to 100%. Linearisation is defined in the positive range only and the negative range will be a mirror image of the positive range with reference to zero.
- With Linearisation Mode set to 2, it is a must to set P1(x) to -100% and P16(x) to +100%. This enables the user to set curves which are not symmetric to the zero position.

*) Output mode = 0

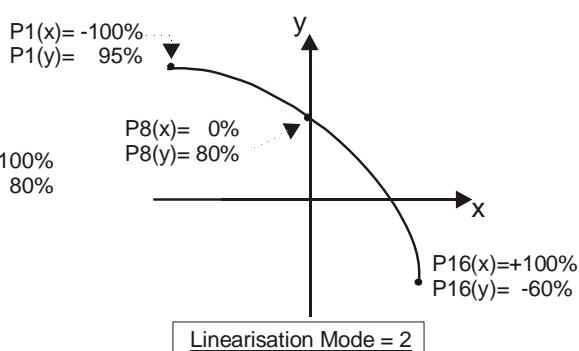
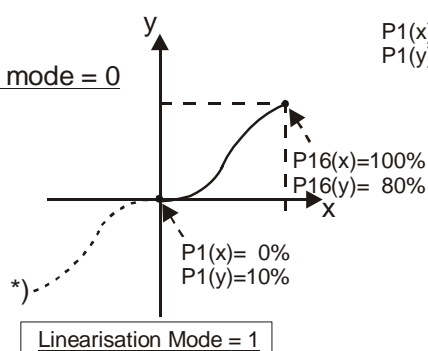

8.2. Data Readout via Serial Interface

All register codes shown in the "Serial Menu" are available for serial readout by PC or PLC. For communication the monitors use the Drivecom Protocol according to ISO 1745. All protocol details can be found in our manual **SERPRO_2a.doc** which is available for download from our homepage

www.motrona.de

To request for a data transmission you must send the following request string to the converter:

EOT	AD1	AD2	C1	C2	ENQ
EOT = control character (Hex 04)					
AD1 = unit address, High Byte					
AD2 = unit address, Low Byte					
C1 = register code, High Byte					
C2 = register code, Low Byte					
ENQ = control character (Hex 05)					

The following example shows the request string for readout of the actual input frequency of a monitor (code :9) from a unit with unit address 11:

ASCII Code:	EOT	1	1	:	9	ENQ
Hex Code:	04	31	31	3A	39	05
Binary Code:	0000 0100	0011 0001	0011 0001	0011 1010	0011 1001	0000 0101

After a correct request, the unit will respond:

STX	C1	C2	x x x x x x x	ETX	BCC
STX = control character (Hex 02)					
C1 = register code, High Byte					
C2 = register code, Low Byte					
xxxxx = readout data					
ETX = control character (Hex 03)					
BCC = block check character					

For all further details see SERPRO_2a.doc.

8.3. "Relay Action", override relay states by programmed states

Models providing relay outputs allow to temporary change the actual relay states according to a programmable ON / OFF pattern, or to temporary freeze the actual switching states. These override functions can be activated by either touching a front key or by a remote command.

8.3.1. Override relay states by programmable ON / OFF states

Parameter "Relay Action" allows to select which of the relays should be affected by the override action. Parameter "Action Polarity" provides setting of the desired "ON / OFF" pattern» (see section 6.2.9, "Switching Menu").

The desired way of activation this override command can be set by the "Command-Menu" (see 6.2.6).

Application example:

You would like to temporary de-energize relays K1 and K3 by touching the key "UP", whilst relay K2 should continue to function normally.

	Action	Parameter settings
1	Assign the Override Command to key "UP"	Key Up Func. = 2
2	Select relays K1 and K3	Relay Action = 5
3	Set the desired switching state of the relays (both de-energized)	Action Polarity = 2

8.3.2. Freeze the actual switching state of all relays

This function will temporary freeze all relays in their actual state for the duration where you press a key or apply a remote command. During the freeze period the relays will no more follow any changes of the input frequency

Application example:

You would like to freeze all relays by applying a "High" signal to input "Control1"

	Action	Parameter settings
1	Assign the Freeze command to input "Control1"	Input 1 Func. = 2
2	Set the input to "Active High" characteristics	Input 1 Config = 1
3	Assign the "Freeze relays" function to the input	Relay Action = 8



- These commands will override the switching states of the selected relays. All relays will immediately return to the actual control state after removing the override command. All internal measuring and control cycles will continue normally.
- To use these functions, please set the corresponding key and input characteristics to static operation only, since dynamic (edge-triggered) operation would make no sense

9. Specifications and Dimensions

Power supply	:	17 VDC - 30 VDC
Current consumption	:	approx. 70mA with 24 VDC
Aux. output for encoder supply	:	5.2V max. 200mA
Inputs Control 1 / 2	:	Ri = 3,9 kOhms, LOW < 2,5V, HIGH > 10V minimum duration of dynamic signals: 50 µsec. minimum duration of static signals: 2 msec.
Encoder inputs	:	RS422, differential voltage > 1 V TTL, LOW < 0.5 V, HIGH > 3 V HTL (NPN / PNP) Ri = 4,75 k, LOW < 4V / HIGH >10V
Input frequency	:	RS422 und TTL differential: 1 MHz HTL und TTL single-ended: 350 kHz
Analogue output (not with DZ 267)	:	+/- 10V, max. 2 mA 0 – 20 mA, 4 – 20 mA (load: max 270 Ohm) Resolution 14 bits, accuracy 0.1% Settling time approx. 200us Step response = 2 x sampling time + 200us
Relays (not with DZ 266)	:	Dry change-over contacts, switching capability 30V / 2A DC or 125V / 0.6A AC or 230V / 0.3A AC Response time approx. 4 msec.
Serial interface	:	RS232 / 2400-38400 Bauds
Ambient temperature	:	Operation: 0 - 45°C (32 – 113°F) Storage: -25 - +70°C (-13 – 158°F)
Housing	:	Plastic housing, suitable for mounting to standard DIN rails (35 mm)
Display	:	LCD with backlight 2 lines at 16 characters, 3,5 mm size
Protection class	:	IP20
Connections	:	25 position screw terminals for cross sections of max. 1.5 mm ² (0.0023 in ²)
Conformity and Standards	:	EMC2004/108/EC: EN 61000-6-2 EN 61000-6-3 LV2006/95/EC: EN 61010-1

Dimensions:

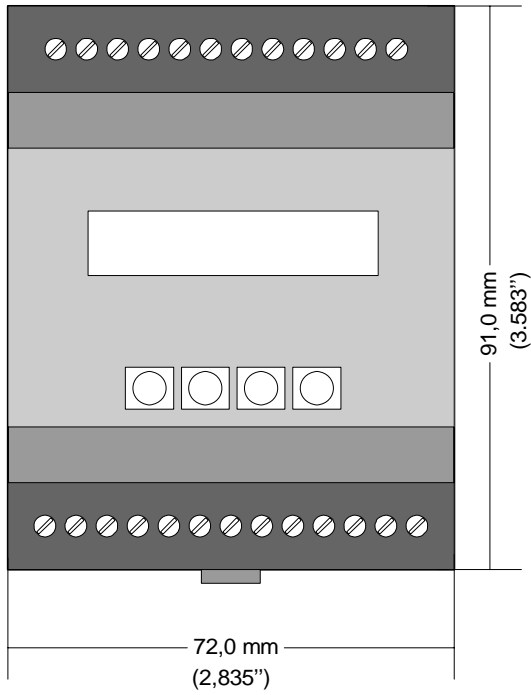

Front view

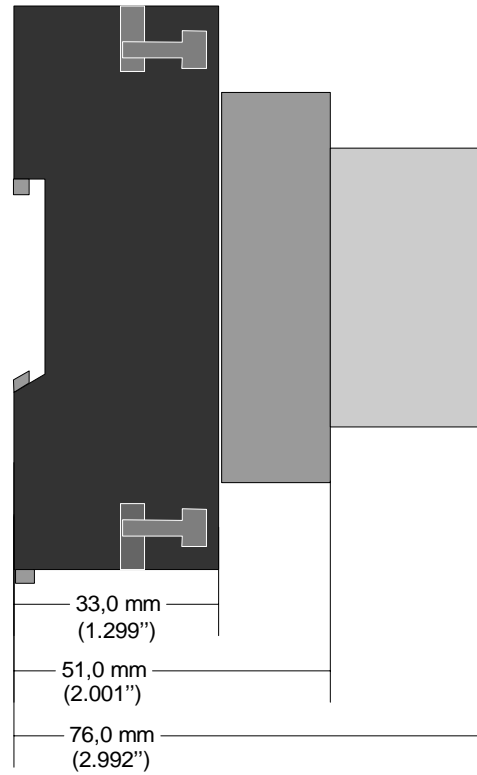

Side view